







SL-VA-900

TECNICAL INFORMATION

Dimension	 L x W x H	570 x 860 x 1660 mm
N. of Pads		8+4
Weight		130 ±10 kg
Elect. System		12V - 20 Ah
Pad Diameter		290 mm
Max SWL (safe working load)		900 kg
Tilting Angle		0°/90°
Slewing Angle		360°

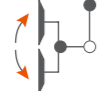

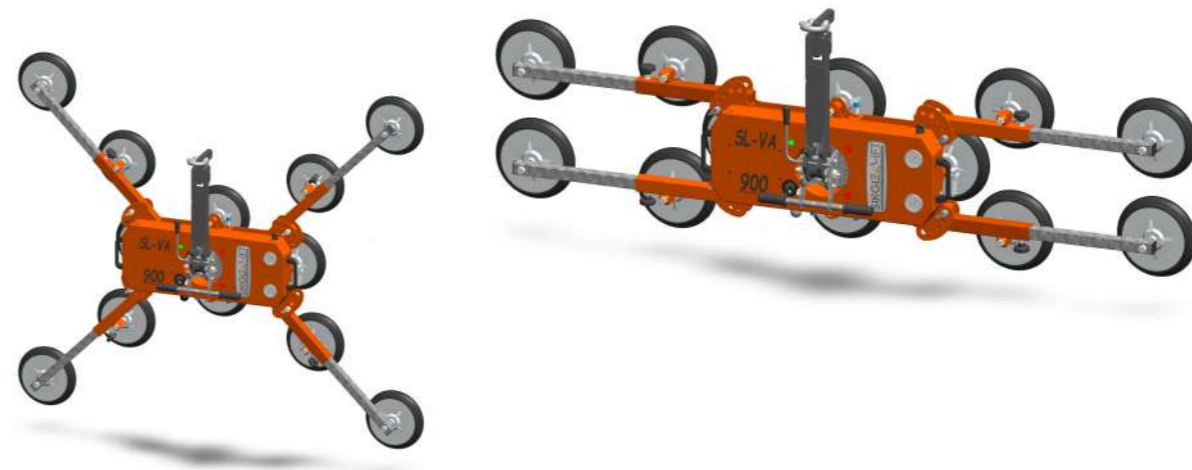
Wireless Remote Control



Wired Remote Control

